

IMPORTANT SAFETY RULES

Read, understand, and follow all instructions carefully before installing and using this product.

Krystal Clear™ Model 638R Filter Pump

220 - 240 V~, 50 Hz, 99 W

Hmax 1.0 m, H min 0.19 m, IPX5/IPX7

Max. Water Temperature 35 °C



Don't forget to try these other fine Intex products: pools, pool accessories, inflatable pools and in-home toys, airbeds and boats available at fine retailers or visit our website.



©2009 Intex Marketing Ltd. - Intex Development Co. Ltd. - Intex Trading Ltd. - Intex Recreation Corp.

All rights reserved/Tous droits réservés/Todos los derechos reservados/Alle Rechte vorbehalten. Printed in China/Imprimé en Chine/Impreso en China/Gedruckt in China.

®™ Trademarks used in some countries of the world under license from/®™ Marques utilisées dans certains pays sous licence de/Marcas registradas utilizadas en algunos países del mundo bajo licencia de/Warenzeichen verwendet in einigen Ländern der Welt in Lizenz von/Intex Marketing Ltd. to/à/a/an Intex Trading Ltd., Intex Development Co. Ltd., G.P.O. Box 28829, Hong Kong & Intex Recreation Corp., P.O. Box 1440, Long Beach, CA 90801 • Distributed in the European Union by/Distribué dans l'Union Européenne par/Distribuido en la unión Europea por/Vertrieb in der Europäischen Union durch/Intex Trading B.V., P.O. Box nr. 1075 - 4700 BB Roosendaal - The Netherlands

TABLE OF CONTENTS

Warnings..... 3

Parts List & Reference..... 4-5

Setup Instructions 6-8

Maintenance..... 9-10

Pool Care and Chemicals..... 9

Long Term Storage..... 10

Troubleshooting Guide..... 11

Common Pool Problems..... 12

General Aquatic Safety..... 13

Limited Warranty..... 14

Intex Service Center Locations..... 15

IMPORTANT SAFETY RULES

Read, Understand and Follow All Instructions Carefully Before Installing and Using this Product.

READ AND FOLLOW ALL INSTRUCTIONS

WARNING









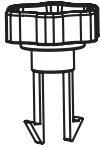

- To reduce the risk of injury, do not permit children to use this product. Always supervise children and those with disabilities.
- Children must stay away from this product and electrical cord(s).
- Children should be supervised to ensure that they do not play with the appliance.
- This appliance is not intended for use by persons (including children) with reduced physical, sensory or mental capabilities, or lack of experience and knowledge. They must at all times be supervised by a knowledgeable and experienced adult responsible for their safety.
- Assembly and disassembly by adults only.
- Risk of electric shock. Connect this product only to a grounding type receptacle protected by a ground-fault circuit interrupter (GFCI) or residual current device (RCD). Contact a qualified electrician if you cannot verify that the receptacle is protected by a GFCI/RCD. Use a qualified electrician to install the GFCI/RCD, which has a maximum rate of 30mA. Do not use a portable residual current device (PRCD).
- Always unplug this product from the electrical outlet before removing, cleaning, servicing or making any adjustment to the product.
- The plug must be accessible after product is installed.
- Do not bury the electrical cord. Locate the cord where it will not be damaged by lawn mowers, hedge trimmers and other equipment.
- The supply cord cannot be replaced. If the cord is damaged the appliance should be scrapped.
- To reduce the risk of electric shock, do not use extension cords, timers, plug adaptors or converter plugs to connect unit to electric supply; provide a properly located outlet.
- Do not attempt to plug in or unplug this product while standing in water or when your hands are wet.
- Keep this product more than 2m away from the pool. (for France only).
- Keep the plug of this product more than 3.5m away from the pool.
- Position this product away from the pool, so as to prevent children from climbing on it and accessing the pool.
- Do not operate this product when pool is occupied.
- This product is for use with storable pools only. Do not use with permanently installed pools. A storable pool is constructed so that it may be readily disassembled for storage and reassembled to its original configuration.
- This product is intended to be used only for the purposes described in the manual!

FAILURE TO FOLLOW THESE WARNINGS MAY RESULT IN PROPERTY DAMAGE, ELECTRIC SHOCK, ENTANGLEMENT OR OTHER SERIOUS INJURY OR DEATH.

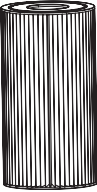
These product warnings, instructions and safety rules provided with the product represent some common risks of water recreation devices and do not cover all instances of risk and danger. Please use common sense and good judgement when enjoying any water activity.

SAFETY RULES

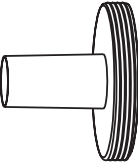
PARTS LIST

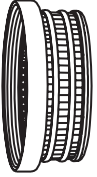
1 	2 	3 
4 	5 	6 
7 	8 	9 
10 	11 	

NOTE: Drawings for illustration purpose only. May not reflect actual product. Not to scale.

PARTS LIST

PARTS REFERENCE

Before assembling your product, please take a few minutes to check the contents and become familiar with all the parts.

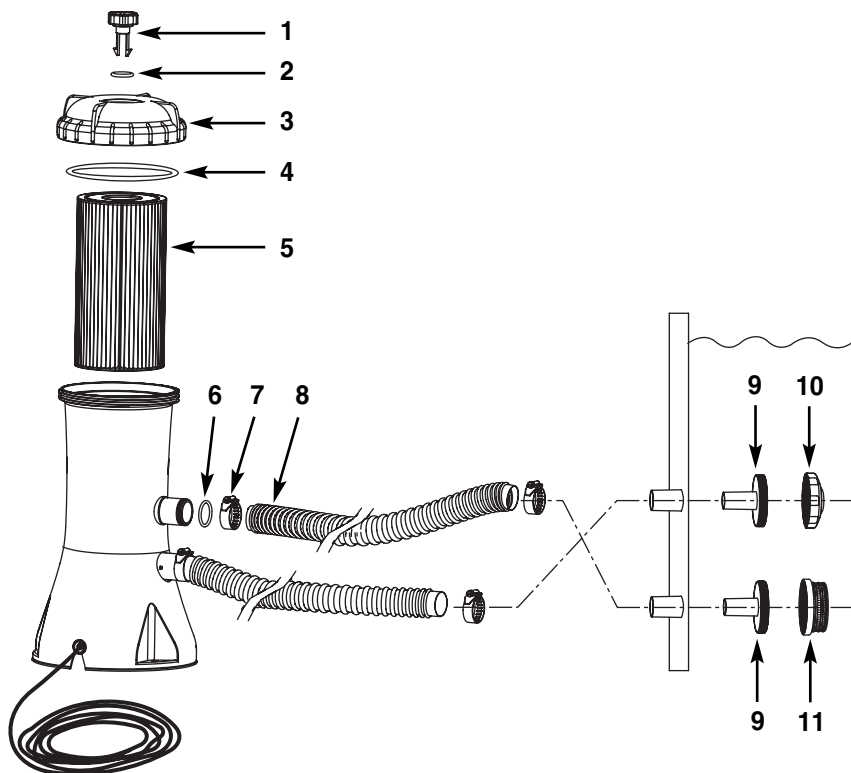

NOTE: Drawings for illustration purpose only. May not reflect actual product. Not to scale.

REF. NO.	DESCRIPTION	QTY.	SPARE PART NO.
1	AIR RELEASE VALVE	1	10460
2	VALVE O-RING	1	10264
3	THREADED COVER	1	10459
4	COVER SEAL	1	10325
5	FILTER CARTRIDGE (59900)	1	
6	HOSE SEAL	2	10134
7	HOSE CLAMP	4	10122
8	HOSE	2	10399
9	STRAINER CONNECTOR	2	11070
10	POOL INLET NOZZLE	1	11071
11	STRAINER GRID	1	11072

When ordering parts, be sure to quote the model number and part numbers.

PARTS REFERENCE

SETUP INSTRUCTIONS

Be sure you have access to water to fill the pool and chemicals for the water. A small coin can be used to tighten the hose clamps (7).

IMPORTANT: This filter pump is shipped with the air release valve (1) open (open the air release valve if necessary). DO NOT replace the air release valve until you reach STEP #8. Failure to follow these instructions will result in air trapped inside filter housing; the motor will run dry, be noisy and malfunction.

1. Assemble above-ground-pool first. Carefully follow the pool's installation instructions.
2. Place the filter pump the length of the hose away from the pool wall where the lower black protruding hose connection is "sticking-out".
3. Insert the nozzle union (9 & 10) into the upper protruding hose connections. Then insert the strainer union (9 & 11) into the lower protruding hose connections. The hoses (8) fit over the strainers inserted into the connections.
4. There are two hoses to be connected to the filter pump hose connections. With hose clamps (7), fasten one of the hoses (8) to the lower protruding hose connection (marked "+" on the pool liner) and to the upper pump connection (marked "+").
5. Connect the second hose to the remaining upper protruding hose connection and to the lower pump connection. Make sure all the hose clamps (7) are tight.
6. Twist the filter pump's threaded cover (3) in a clockwise direction to be sure it is on "tight". Use only your hands to tighten the top. Do not tighten with tools such as pliers.
7. Fill the pool to a level of at least 1-2 inches above the top connection. The water will automatically flow down into the pump.
8. When water starts flowing out of the air release valve hole, screw in the air release valve back into the filter housing cover. Do not over tighten the valve.
NOTE: Venting the system is necessary for air to escape as the filter housing fills with water.
9. Connect the filter pump to the power outlet. The filter pump is now filtering the water.

WARNING

Risk of electric shock. Connect this product only to a grounding type receptacle protected by a ground-fault circuit interrupter (GFCI) or residual current device (RCD). Contact a qualified electrician if you cannot verify that the receptacle is protected by a GFCI/RCD. Use a qualified electrician to install the GFCI/RCD, which has a maximum rate of 30mA. Do not use a portable residual current device (PRCD).

10. Operate the filter pump until the desired water clarity is obtained.

SETUP INSTRUCTIONS (continued)**⚠ WARNING**

Position this product away from the pool, so as to prevent children from climbing on it and accessing the pool.

To inspect and change the filter cartridge, disconnect line cord, unscrew the pool inlet nozzle (10) and strainer grid (11) from the strainer connectors and insert the hat-like plugs into the strainer connectors before servicing the filter. After service, open the air release valve, remove the plugs, allow any air to escape through the valve before tightening the valve again and replace the pool inlet nozzle (10) and strainer grid (11). The pump is now primed with water again and may be turned on.

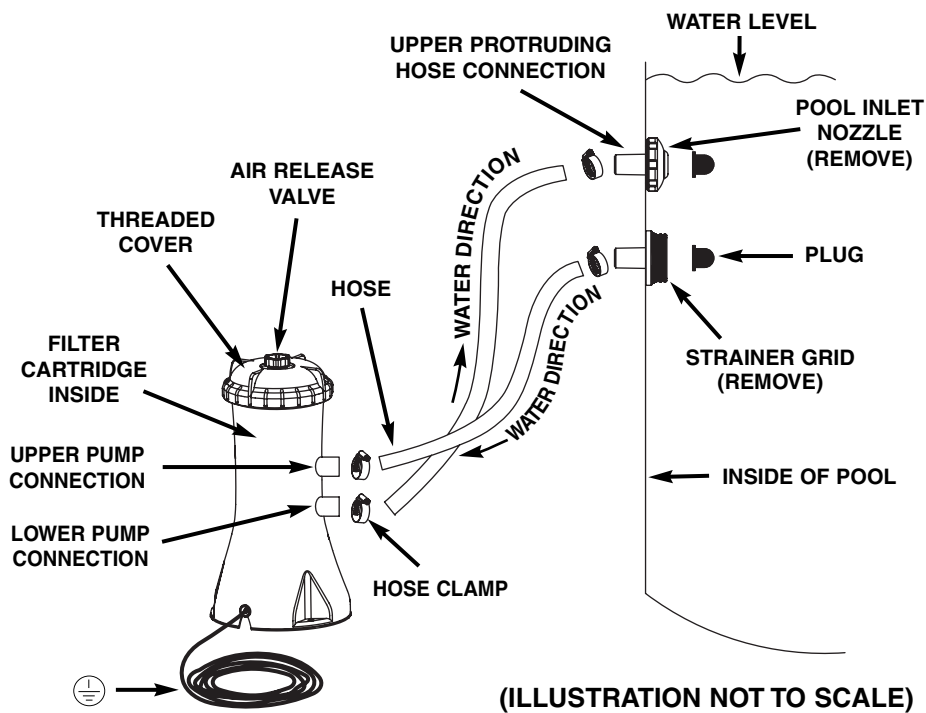

The installation instruction shall provide information on requirements specified for the electrical installation and shall include reference to national wiring rules.

FILTER PUMP STATIONARY MOUNTING OPTION

There are three mounting holes located at the bottom of the filterpump base. These holes are provided because various country's regulations, especially in the European community, require the filterpump to be secured to the ground or to a base in a permanent upright position.

These three holes form a triangle pattern and are 145mm from each other. The holes are slotted with a 7mm width.

The filterpump can be mounted on a cement base or onto a wooden structure to prevent accidental falling over. Total assembly must exceed 18kg. The drawings on the following show two possible ways of upright mounting.

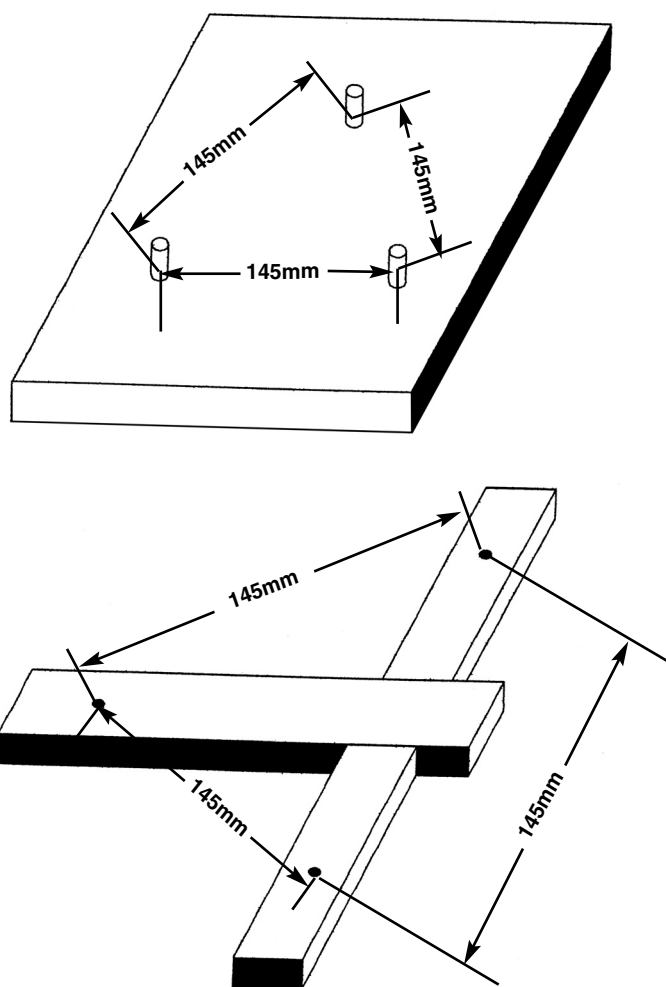

 -- (3) x M6 HEXAGON LOCK-NUTS

 -- (3) x M6 HEXAGON HEAD BOLTS

SETUP INSTRUCTIONS

POOL CARE AND CHEMICALS

- All pools require care to keep the water clear and hygienically clean. With proper chemical control, your filter will help attain this objective. Consult your pool supply dealer for instructions regarding the proper use of chlorine, algaecide and other chemical agents required for sparkling clear water.
- Keep pool chemicals away from children.
- Do not replenish chemicals in pool while pool is occupied. Skin or eye irritations could occur.
- Daily pH checking and chemical treatment of the water is very important and can not be overemphasized. Chlorine, algaecide and maintenance of proper pH levels are required when filling the pool as well as during the season. Consult your local swimming pool supply store for instructions.
- The season's first filling of the pool may have brackish water requiring extra water additives and extra filter changes. Do not allow swimming in pool until the pH level is balanced. Consult your local swimming pool supply store for instructions.
- Keep spare filter cartridges on hand. Replace cartridges every two weeks.
- Chlorinated water may damage lawns, gardens or shrubbery as children play in the pool and splash water outside the pool. Lawn areas underneath the pool liner will be destroyed. Note that some types of grass may grow through the liner.
- Filter run time depends on pool size, weather and usage level. Experiment with various run times so as to produce clean clear water.

CAUTION

Concentrated chlorine solutions may damage the pool liner. Always follow the chemical manufacturer's directions, and the health and hazard warnings.

CLEANING OR REPLACING FILTER CARTRIDGES

It is recommended that the filter cartridge be replaced at least every 2 weeks.

1. Make sure filter pump is not operating. Disconnect line cord.
2. To prevent water from escaping the pool, unscrew the pool inlet nozzle **(10)** and strainer grid **(11)** from the strainer connectors and insert the hat-like plugs into the strainer connectors.
3. In a counter-clockwise motion, remove threaded cover **(3)** and cover seal **(4)**. Be careful not to lose the cover seal **(4)**.
4. Remove filter cartridge **(5)** to clean it. The filter may be cleaned from the spray from a water hose.
5. Use judgement as to whether cartridge needs to be replaced.
6. Return cartridge to filtering position.
7. Return the seal **(4)** and threaded cover **(3)** to their original positions. Tighten the threaded cover **(3)** by hand only, twisting it in a clockwise direction.
8. After service, open the air release valve, remove the plugs, allow any air to escape through the valve before tightening the valve again and replace the pool inlet nozzle **(10)** and strainer grid **(11)**. The pump is now primed with water again and may be turned on.

LONG TERM STORAGE

1. Before emptying your pool for long term storage, or relocation, be sure the water is directed towards an acceptable drain water receptacle away from the house. Check local regulations for specific directions regarding disposal of swimming pool water.
2. Now, drain the pool.
3. When the pool is empty, disconnect all pool hoses **(8)** from the pool and filter pump, simply reverse the set up instructions.
4. Remove the filter cartridge as shown in the Filter Cartridge Cleaning section, steps 2 thru 4.
5. Remove the nozzle and strainer unions from the pool wall. Place the wall plugs into the hose connections. Loosen clamps **(7)** securing the strainer connectors **(9)** before removal.
6. Drain water from the filter pump housing.
7. Leave filter pump pieces and hoses outside to thoroughly air dry.
8. Depending on the cartridge **(5)** usage, a new cartridge may be needed for next season, keep a spare available.
9. Cover the seal **(4)**, air release valve O-ring **(2)** and hose seals **(6)** with petroleum jelly to preserve its resilience during storage.
10. Store the unit and accessories in a dry place. The storage's temperature should be controlled, between 32 degrees Fahrenheit (0 degrees Celsius) and 104 degrees Fahrenheit (40 degrees Celsius) storage location.
11. The original packing can be used for storage.

TROUBLESHOOTING GUIDE

TROUBLE	CAUSE	SOLUTION
FILTER MOTOR FAILS TO START	<ul style="list-style-type: none"> The motor is not plugged in. The fuse box needs checking. The GFCI/RCD circuit breaker is tripped. Motor too hot and overload protection shut motor off. 	<ul style="list-style-type: none"> Filter cord must be plugged into a 3 wire outlet that is protected by a Class A Ground Fault Circuit Interrupter, or RCD. Reset circuit breaker. If circuit breaker trips repeatedly, your electrical system may have a defect. Turn off circuit breaker and call an electrician to correct the problem. Let motor cool down.
FILTER DOESN'T CLEAN POOL	<ul style="list-style-type: none"> Improper chlorine or pH levels. Filter cartridge is dirty. Damaged cartridge. Excessively dirty pool. The strainer screen is restricting the water flow. 	<ul style="list-style-type: none"> Adjust the chlorine and pH level. Consult your local swimming pool supply stores. Clean or replace cartridge. Check the cartridge for holes. Replace if damaged. Operate the filter for longer periods. Clean the strainer screen at the inlet.
FILTER DOESN'T PUMP WATER OR FLOW IS VERY SLOW	<ul style="list-style-type: none"> Clogged inlet or discharge. An air leak on the intake line. Scale or buildup on cartridge. Excessively dirty pool. Dirty filter cartridge. The nozzle and strainer connection are reversed. 	<ul style="list-style-type: none"> Clear any obstructions in the intake hose by discharging it inside pool wall. Tighten hose clamps, check hoses for damage, check pool water level. Replace cartridge. Clean cartridge more often. Install the nozzle at the upper position of the pool inlet, and the strainer at the lower position of the pool outlet.
PUMP DOESN'T WORK	<ul style="list-style-type: none"> Low water level. Strainer screen plugged up. An air leak on the intake hose. Faulty motor or the impeller is jammed. An air lock inside the cartridge chamber. 	<ul style="list-style-type: none"> Fill pool to correct water level. Clean strainer screens at pool inlet. Tighten hose clamps, check hose for damage. Clear any sticks or leaves in the intake hose. Open the release valve at top of pump.
TOP COVER LEAKING	<ul style="list-style-type: none"> O-ring missing. Cover is not tight. Filter cartridge is dirty. 	<ul style="list-style-type: none"> Remove cover & check for O-ring. Tighten cover (Manually). Replace or clean cartridge.
HOSE LEAKING	<ul style="list-style-type: none"> Hose clamps are not well-fitted. 	<ul style="list-style-type: none"> Tighten or change hose clamps.
AIR LOCK	<ul style="list-style-type: none"> There's air trapped in the pump housing and inlet hose. 	<ul style="list-style-type: none"> Open air release valve, lift and lower the inlet hose until water starts to flow out of the air release valve, close air release valve.

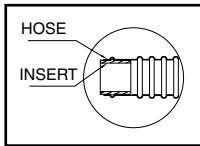

- The white inserts at both ends of the hoses shall remain inside and shall be firmly inserted in the hose. Do not remove the white inserts from the hoses. These white inserts are not serviceable parts.
- To facilitate the connection of the hoses into the black protruding hose connectors on the pool wall, you may use soapy water solution (mix 6 drops of dish detergent in 1/2 a cup of water) to lubricate the inserts by simply dipping the hose ends into the solution. Continue per owner's manual.
- Do not use lubricants such as machine or industrial oil or grease.

TROUBLESHOOTING GUIDE

COMMON POOL PROBLEMS

PROBLEM	DESCRIPTION	CAUSE	SOLUTION
ALGAE	<ul style="list-style-type: none"> Greenish water. Green or black spots on pool liner. Pool liner is slippery and/or has a bad odor. 	<ul style="list-style-type: none"> Chlorine and pH levels need adjustment. 	<ul style="list-style-type: none"> Super chlorinate with shock treatment. Correct pH to your pool store's recommended level. Vacuum pool bottom. Maintain proper chlorine level.
COLORED WATER	<ul style="list-style-type: none"> Water turns blue, brown, or black when first treated with chlorine. 	<ul style="list-style-type: none"> Copper, iron or manganese in water being oxidized by the added chlorine. This is Common. 	<ul style="list-style-type: none"> Adjust pH level to the recommended level. Run filter until water is clear. Clean cartridge frequently.
SUSPENDED MATTER IN WATER	<ul style="list-style-type: none"> Water is cloudy or milky. 	<ul style="list-style-type: none"> "Hard water" caused by a too high pH level. Chlorine content is low. Foreign matter in water. 	<ul style="list-style-type: none"> Correct the pH level. Check with your pool dealer for advice. Adjust the chlorine level. Clean or replace your filter.
CHRONIC LOW WATER LEVEL	<ul style="list-style-type: none"> Level is lower than on previous day. 	<ul style="list-style-type: none"> Rip or hole in pool liner or hoses. The drain valves are loose. 	<ul style="list-style-type: none"> Repair with a patch kit. Finger tighten all caps.
SEDIMENT ON POOL BOTTOM	<ul style="list-style-type: none"> Dirt or sand on pool floor. 	<ul style="list-style-type: none"> Heavy use, getting in and out of pool. 	<ul style="list-style-type: none"> Use Intex pool vacuum to clean bottom of pool.
SURFACE DEBRIS	<ul style="list-style-type: none"> Leaves, insects etc. 	<ul style="list-style-type: none"> Pool too close to trees. 	<ul style="list-style-type: none"> Use Intex pool skimmer.

IMPORTANT

If you continue to experience difficulty, please contact our Consumer Service Department for assistance. See back cover for contact information.

GENERAL AQUATIC SAFETY

Water recreation is both fun and therapeutic. However, it involves inherent risks of injury and death. To reduce your risk of injury, read and follow all product, package and package insert warnings and instructions. Remember, however, that product warnings, instructions and safety guidelines cover some common risks of water recreation, but do not cover all instances or risk and or danger.

For additional safeguards, also familiarize yourself with the following general guidelines as well as guidelines provided by nationally recognized Safety Organizations:

- Demand constant supervision.
- Learn to swim.
- Take the time to learn CPR and first aid.
- Instruct anyone who is watching your children about potential pool hazards and about the use of protective devices such as locked doors, barriers, etc.
- Teach children what to do in case of an emergency.
- Always use common sense and good judgement when enjoying any water activity.
- Supervise, supervise, supervise.

LIMITED WARRANTY

Your Krystal Clear™ Filter-Pump has been manufactured using the highest quality materials and workmanship. All Intex products have been inspected and found free of defects prior to leaving the factory. This Limited Warranty applies only to the Krystal Clear™ Filter-Pump.

The provisions of this Limited Warranty apply only to the original purchaser and is not transferable. This Limited Warranty is valid for a period of one (1) year from the date of the initial retail purchase. Keep your original sales receipt with this manual, as proof of purchase will be required and must accompany warranty claims or the Limited Warranty is invalid.

If a manufacturing defect is found within this one (1) year period, please contact the appropriate Intex Service Center listed in this manual. The Service Center will determine the validity of the claim.

IMPLIED WARRANTIES ARE LIMITED TO THE TERMS OF THIS WARRANTY AND IN NO EVENT SHALL INTEX, THEIR AUTHORIZED AGENTS OR EMPLOYEES BE LIABLE TO THE BUYER OR ANY OTHER PARTY FOR DIRECT OR CONSEQUENTIAL DAMAGES OR LIABILITIES.

This Limited Warranty does not apply if the Krystal Clear™ Filter-Pump is subject to negligence, abnormal use or operation, accident, improper operation, improper voltage or current contrary to operating instructions, or to damage by circumstances beyond Intex's control, including but not limited to, ordinary wear and tear and damage caused by exposure to fire, flood, freezing, rain, or other external environmental forces. This Limited Warranty applies only to those parts and components sold by Intex. The Limited Warranty does not cover unauthorized alterations, repairs or disassembly by anyone other than Intex Service Center personnel.

The Limited Warranty is also not applicable if this product is used with another product other than an Intex product, when setting up your pool.

The costs associated with the loss of pool water, chemicals or water damage are not covered by this warranty. Injury or damage to any property or person is not covered by this warranty.

For service questions or to order replacement parts, please contact the appropriate office listed below or visit www.intexdevelopment.com for answers to most frequently asked questions.

AREAS	LOCATION	AREAS	LOCATION
• ASIA	INTEX DEVELOPMENT CO. LTD. 8TH FLOOR, DAH SING FINANCIAL CENTRE, 108 GLOUCESTER ROAD, WANCHAI, HONG KONG TEL: 852-28270000 FAX: 852-23118200 E-mail: xmservicesupport@intexcorp.com.cn Website: www.intexdevelopment.com	• ARGENTINA	JARSE INDUSTRIAL Y COMERCIAL S.A MANUEL GARCIA N°124, PARQUE PATRICO, BUENOS AIRES, ARGENTINA TEL: 4942-2238 (interno 106); TEL: 4942-2238 (interno 145) E-mail: Martin.Cosoletto@jarse.com.ar E-mail: Daniel.Centurion@jarse.com.ar
• EUROPE	INTEX TRADING B.V. POSTBUS 1075, 4700 BB ROOSENDAAL, THE NETHERLANDS TEL: 31-(0)165-593939 FAX: 31-(0)165-593969 E-mail: service@intexcorp.nl Website: www.intexcorp.nl	• PERU	COMEXA S.A. AVENIDA COMANDANTE ESPINAR 142, MIRAFLORES, LIMA, PERU TEL: 446-9014
• FRANCE	INTEX SERVICE FRANCE (CASS INTEX FRANCE) 52, ROUTE NATIONALE, 39190 BEAUFORT, FRANCE TEL: 08 90 71 20 39 FAX: 03 84 25 18 09 E-mail: sav@intexcorp.com.fr Website: www.intex.fr	• SAUDI ARABIA	SAUDI ARABIAN MARKETING & AGENCIES CO. LTD. PRINCE AMIR MAJED STREET, AL-SAFA DISTRICT, JEDDAH, KINGDOM OF SAUDI ARABIA TEL: 966-2-693 8496 FAX: 966-2-271 4084 E-mail: toy@samaco.com.sa Website: www.samaco.com.sa
• GERMANY	STEINBACH VERTRIEBSGMBH AN DER WELLE 4 60322 FRANKFURT TEL: 0800 468397665 FAX: + 43 (7262) 61439 E-mail: service@intexcorp.de Website: www.intexcorp.de	• AUSTRIA	STEINBACH VERTRIEBSGMBH AISTINGERSTRASSE 2 4311 SCHWERTBERG TEL: 0800 468397665 FAX: + 43 (7262) 61439 E-mail: service@intexcorp.at Website: www.intexcorp.at
• ITALY	A & A MARKETING SERVICE VIA RAFFAELLO SANZIO 20058 VILLASANTA (MI) TEL: 199 12 19 78 FAX: +39 039 2058204 E-mail: intex@aeamarketingservice.com Website: www.intexitalia.com	• CZECH REPUBLIC / EASTERN EUROPE	INTEX TRADING S.R.O. BENESOVSKA 23, 101 00 PRAHA 10, CZECH REPUBLIC TEL: +420-267 313 188 FAX: +420-267 312 552 E-mail: info@intexcorp.cz
• UK	TOY BROKERS LTD MARKETING HOUSE, BLACKSTONE ROAD, HUNTINGDON, CAMBS. PE29 6EJ, UK TEL: 0844 561 7129 FAX: 01480 414761 E-mail: sales@toybrokers.com Website: www.intexpares.com	• BELGIUM	N.V. SIMBA-DICKIE BELGIUM S.A. MOESKROENSESTEENWEG 383C, 8511 AALBEKE, BELGIUM TEL: 0800 92088 FAX: 32-56.26.05.38 E-mail: intex@nicotoy.be E-mail: intexsupport@nicotoy.be
• SWITZERLAND	GWM AGENCY GARTEN-U. WOHNMOBEL, RAFFELSTRASSE 25, POSTFACH, CH-8045 ZÜRICH/SWITZERLAND TEL: 0900 455456 or +41 44 455 50 60 FAX: +41 44 455 50 65 E-mail: gwm@gwm.ch Website: www.gwm.ch	• DENMARK	K.E. MATHIASSEN A/S SINTRUPVEJ 12, DK-8220 BRABRAND, DENMARK TEL: +45 89 44 22 00 FAX: +45 86 24 02 39 E-mail: intex@keleg.dk Website: www.intexnordic.com
• SPAIN	KOKIDO BVI LIMITED C/ LAS MORERAS PARCELA 1 NAVES 7-10 POL. IND. CAMPOROSSO 28350 CIEMPOZUELOS, MADRID TEL: 34 902 35 10 45 FAX: +34 902 45 15 60 E-mail: info@kokido.com	• SWEDEN	LEKSAM AB BRANDSVIGSGATAN 6, S-262 73 ANGELHOLM, SWEDEN TEL: +46 431 44 41 00 FAX: +46 431 190 35 E-mail: intex@leksam.se Website: www.intexnordic.com
• PORTUGAL	KOKIDO BVI LIMITED AVENIDA ANTONIO AUGUSTO AGUIAR, N°163 - 5°DTº 1050-014 LISBOA PORTUGAL TEL: 351 707 200 936 FAX: 351 213 519 550 E-mail: info@kokido.com	• NORWAY	NORSTAR AS PINDSLEVEEN 1, N-3221 SANDEFJORD, NORWAY TEL: +47 33 48 74 10 FAX: +47 33 48 74 11 E-mail: intex@norstar.no Website: www.intexnordic.com
• AUSTRALIA	HUNTER OVERSEAS PTY LTD LEVEL 1, 225 BAY STREET, BRIGHTON, VICTORIA, AUSTRALIA TEL: 61-3-9596-2144 or 1800-224-094 FAX: 61-3-9596-2188 E-mail: enquiries@hunteroverseas.com.au Website: www.hunteroverseas.com.au	• FINLAND	NORSTAR OY SUOMALAISENTIE 7, FIN-02270 ESPOO, FINLAND TEL: +358 9 8190 530 FAX: +358 9 8190 5335 E-mail: info@norstar.fi Website: www.intexnordic.com
• NEW ZEALAND	HAKA NEW ZEALAND LIMITED UNIT 4, 11 ORBIT DIVE, ALBANY, AUCKLAND 0757, NEW ZEALAND TEL: 649-4159213 FAX: 649-4159212 E-mail: geoff@hakanz.co.nz	• RUSSIA	LLC BAUER KIEVSKAYA STR., 20, 121165 MOSCOW, RUSSIA TEL: 099-249-9400/8626/9802 FAX: 095-742-8192 E-mail: intex.russia@gmail.com Website: www.intex.su
• MIDDLE EAST REGION	FIRST GROUP INTERNATIONAL AL MOOSA GROUP BUILDING, 1ST FLOOR, OFFICE 102 & 103, UMM HURAIR ROAD, KARAMA, DUBAI, UAE TEL: 00971-4-3373322 FAX: 00971-4-3375115 E-mail: info@firstgroupinternational.com Website: www.firstgroupinternational.com	• POLAND	KATHAY HASTER UL. LUTYCKA 3, 60-415 POZNAN TEL: +48 61 8498 381/380 FAX: +48 61 8474 487 E-mail: inx@kathay.com.pl Website: www.intexpoland.pl
• SOUTH AFRICA	WOOD & HYDE 15-17 PACKER AVENUE, INDUSTRIA 2, CAPE TOWN, SOUTH AFRICA 7460 TEL: 27-21-0800-204-692 FAX: 27-21-505-5600 E-mail: ygoldman@melbro.co.za	• HUNGARY	RECONTRA LTD./RICKI LTD. H-1113 BUDAPEST, DARÓCZI ÚT 1-3, HUNGARY TEL: +361 372 5200/113 FAX: +361 209 2634 E-mail: service@recontra.hu
• CHILE / URUGUAY	COMEXA S.A. EL JUNCAL 100, PARQUE INDUSTRIAL PORTEZUELO, QUILICURA, SANTIAGO, CHILE. TEL: 600-822-0700 E-mail: serviciotecnico@silfa.cl	• BRASIL	KONSUL MARKETING & SALES LTDA RUA ANTONIO DAS CHAGAS, 1.528 - CEP. 04714-002, CHÁCARA SANTO ANTONIO - SÃO PAULO - SP - BRASIL TEL: 55 (11) 5181 4646 FAX: 55 (11) 5181 4646 E-mail: sacintexbrasil@uol.com.br
		• ISRAEL	ALFIT TOYS LTD MOSHAV NEHALIM, MESHEK 32, 49950, ISRAEL TEL: +972-3-9076666 FAX: +972-3-9076660 E-mail: michald@chagim.co.il



Correct Disposal of this product

This marking indicates that this product should not be disposed with other household wastes throughout the EU. To prevent possible harm to the environment or human health from uncontrolled waste disposal, recycle it responsibly to promote the sustainable reuse of material resources. To return your used device, please use the return and collection systems or contact the retailer where the product was purchased. They can take this product for environmental safe recycling.



Elimination appropriée du produit

Ce symbole signifie que ce produit ne doit pas être jeté avec les autres déchets ménagers dans l'Union européenne. Pour éviter tout dommage potentiel pour l'environnement ou la santé humaine résultant d'un dépôt incontrôlé de ce déchet, le recycler afin de favoriser une réutilisation durable des ressources matérielles. Pour rapporter votre appareil usagé, merci d'utiliser les systèmes de retour et de collecte ou de contacter le détaillant qui vous a vendu ce produit.



Deshearse de los residuos de este producto

Esta etiqueta indica que este producto no podrá ser eliminado en la basura normal. Para prevenir posibles agresiones a la salud y al medio ambiente consulte donde deshearse del producto según la normativa de su país. Para desechar el artículo utilice sistemas de reciclado o contacte con el minorista donde lo compró.



Korrekte Entsorgung dieses Produkts

Innerhalb der EU weist dieses Symbol darauf hin, dass dieses Produkt nicht über den Hausmüll entsorgt werden darf. Altgeräte enthalten wertvolle recyclingfähige Materialien, die einer Wiederverwertung zugeführt werden sollten und um der Umwelt bzw. der menschlichen Gesundheit nicht durch unkontrollierte Müllbeseitigung zu schaden. Bitte entsorgen Sie Altgeräte deshalb über geeignete Sammelsysteme oder senden Sie das Gerät zur Entsorgung an die Stelle, bei der Sie es gekauft haben. Diese wird dann das Gerät der stofflichen Verwertung zuführen.



Smaltimento corretto del prodotto

Il presente simbolo indica che questo prodotto non deve essere smaltito con gli altri rifiuti domestici nelle nazioni dell'Unione Europea. Per evitare possibili effetti negativi sull'ambiente e sulla salute, riciclare l'apparecchio per promuovere un riutilizzo sostenibile delle risorse materiali. Per riconsegnare l'apparecchio usato, utilizzare i sistemi di raccolta e restituzione della ditta produttrice presso la quale il prodotto è stato acquistato. La ditta produttrice si preoccuperà di riciclare il prodotto in maniera sicura per l'ambiente.



Correcte Verwijdering van dit product

Deze markering duidt erop dat dit product niet kan worden verwijderd met andere huishoudelijk afval binnen de EU. Om mogelijke schade aan het milieu of de menselijke gezondheid door ongecontroleerde afvalverwijdering te voorkomen, recycle deze op een verantwoorde manier om een houdbare hergebruik van materiële rijkdommen te stimuleren. Om uw gebruikte apparaat terug te brengen, gebruik de terugbreng- en verzamelpunten of neem contact op met de winkelier waar het product is aangekocht. Zij kunnen dit product terugnemen voor milieuvriendelijke recycling.



Descarte corecto deste produto

Está marca indica que este produto não deveria ser descartado com outros aparelhos domésticos em toda UE. Prevenir possíveis danos ao ambiente ou a saúde humana do descontrolado do descarte, e recicla para promover responsavelmente o sustentável re-uso das fontes materiais. Devolva seu dispositivo usado, favor usar o sistema de coletas ou contate a loja onde o produto foi comprado. Eles podem levar este produto para reciclagem e para segura ambiental.



Korrekt bortskaffelse af dette produkt

Denne markering indikerer at dette produkt ikke burde bortskaffes sammen med anden husholdnings skrald igennem EU. For at forhindre evt. miljøskader eller menneskelige skader fra ukontrolleret affaldsbortskaffelse, genbruge det ansvarligt for at promovere bæredygtig genbrug af materiale resourcer. For at returnere dit brugte apparat, venligst bruge returnerings og kollektions systemer eller kontakte butikken hvor produktet var købt. De kan tage produktet til miljøvenligt genbrug.



Σωστή απορρίψη αυτού του προϊόντος

Αυτή η σήμανση ορίζει ότι αυτό το προϊόν δεν θα πρέπει να απορριφτεί με οικιακά απορρίμματα σε όλη την Ευρωπαϊκή Ένωση. Για να αποφευχθεί η μόλυνση του περιβάλλοντος ή βλάβες στην ανθρώπινη υγεία από μη ελεγχόμενη απορρίψιση, ανακυκλώστε το υπεύθυνα γύρω να προωθήσετε την οικολογική επαναρρριψιολογηση των υλικών πηγών. Για να ελαττώσετε τη χρησιμοποσημενη σας συσκευή, παρακαλώ ακολουθήστε τα συστήματα επιστροφής και συλλογής ή επικοινωνήστε με το κατάστημα από όπου το προϊόν αγοράστηκε. Μπορούν να ανακυκλωθούν ασφαλώς αυτό το προϊόν.



Правильная утилизация данного изделия

Данная маркировка указывает на то, что изделие не должно утилизироваться вместе с остальными бытовыми отходами по всему ЕС. Для предотвращения возможного причинения вреда окружающей среде или здоровью человека от неконтролируемой утилизации отходов подвргните его обязательной рециркуляции для поддержания рационального повторного использования материальных ресурсов. Для рециркуляции вашего использованного устройства используйте системы рециркуляции и сбора или обратитесь в розничный магазин, в котором данное изделие было приобретено. Они могут принять данное изделие для проведения безопасной для окружающей среды рециркуляции.

