

IMPORTANT SAFETY RULES

Read, understand, and follow all instructions carefully before installing and using this product.

Oval Frame Pool

18' x 10' (549 cm x 305 cm),
20' x 12' (610 cm x 366 cm),
24' x 12' (732 cm x 366 cm) &
28' x 12' (853 cm x 366 cm)



For illustrative purposes only. Accessories may not be provided with pool.

Don't forget to try these other fine Intex products: pools, pool accessories, inflatable pools and in-home toys, airbeds and boats available at fine retailers or visit our website.

OWNER'S MANUAL



©2009 Intex Marketing Ltd. - Intex Development Co. Ltd. - Intex Trading Ltd. - Intex Recreation Corp.

All rights reserved/Tous droits réservés/Todos los derechos reservados/Alle

Rechte vorbehalten. Printed in China/Imprimé en Chine/Impreso en China/Gedruckt in China.

®™ Trademarks used in some countries of the world under license from/®™ Marques utilisées dans certains pays sous licence de/Marcas registradas utilizadas en algunos países del mundo bajo licencia de/Warenzeichen verwendet in einigen Ländern der Welt in Lizenz von/Intex Marketing Ltd. to/à/a/an Intex Trading Ltd., Intex Development Co. Ltd., G.P.O Box 28829, Hong Kong & Intex Recreation Corp., P.O. Box 1440, Long Beach, CA 90801 • Distributed in the European Union by/Distribué dans l'Union Européenne par/Distribuido en la unión Europea por/Vertrieb in der Europäischen Union durch/Intex Trading B.V., P.O. Box nr. 1075 - 4700 BB Roosendaal - The Netherlands

Warnings..... 3

Parts List & Reference..... 4-7

Setup Instructions..... 8-12

Pool Maintenance and Chemicals..... 13-14

Common Pool Problems..... 13

Pool Draining..... 14

Storage..... 14-15

General Aquatic Safety..... 16

Intex Service Center Locations..... 17

Special Introductory note:

Thanks for buying an Intex pool. Please take a few minutes to read this manual before setting up your pool. This information will help extend the pool life and make the pool safer for your family's enjoyment. View the video included before installation. A team of 2-4 people is recommended for pool set up. Additional people will speed up the installation.

IMPORTANT SAFETY RULES

Read, Understand and Follow All Instructions Carefully Before Installing and Using this Product.

WARNING

- **Continuous and competent adult supervision of children and the handicapped is required at all times.**
- Secure all doors, windows and safety barriers to prevent unauthorized, unintentional or unsupervised pool entry.
- Install a safety barrier that will eliminate access to the pool for young children and pets.
- Pool and pool accessories are to be assembled and disassembled by adults only.
- Never dive, jump or slide into an above-ground pool or any shallow body of water.
- Failure to set up pool on flat, level, compact ground could result in the pool's collapse or the possibility that a person lounging in the pool could be swept out.
- Do not lean, straddle, or exert pressure on the inflatable ring or top rim as injury or flooding could occur. Do not allow anyone to sit on, climb, or straddle the sides of the pool.
- Remove all toys and flotation devices from, in and around the pool when it is not in use. Objects in the pool attract young children.
- Keep toys, chairs, tables, or any objects that a child could climb on at least four feet away from the pool.
- Keep rescue equipment by the pool and clearly post emergency numbers at the phone closest to the pool. Examples of rescue equipment: coast guard approved ring buoy with attached rope, strong rigid pole not less than twelve feet (12') [365.76cm] long.
- Never swim alone or allow others to swim alone.
- Keep your pool clean and clear. The pool floor must be visible at all times from the outside barrier of the pool.
- If swimming at night use artificial lighting to illuminate all safety signs, ladders, pool floor and walkways.
- Stay away from the pool when using alcohol or drugs.
- Keep children away from pool covers to avoid entanglement, drowning, or other serious injury.
- Pool covers must be completely removed before pool use. Children and adults cannot be seen under a pool cover.
- Do not cover the pool while you or anyone else is in the pool.
- Keep the pool and pool area clean and clear to avoid slips and falls and objects that may cause injury.
- Protect all pool occupants from recreational water illnesses by keeping the pool water clean. Don't swallow the pool water. Practice good hygiene.
- All pools are subject to wear and deterioration. Certain types of excessive or accelerated deterioration can lead to an operation failure. And can ultimately cause the loss of large quantities of water from your pool. So, therefore it is very important that you properly maintain your pool on a regular basis.
- This pool is for outdoor use only.
- Empty and store the pool when not in use for a longer period.
- While the swimming pool is in use, you will need to operate the filter pump to ensure that there is at least one complete change of water a day. Consult your pump's manual to calculate the necessary operating hours.

POOL BARRIERS AND COVERS ARE NOT SUBSTITUTES FOR CONTINUOUS AND COMPETENT ADULT SUPERVISION.









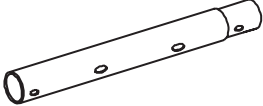
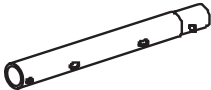
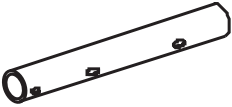

FAILURE TO FOLLOW THESE WARNINGS MAY RESULT IN PROPERTY DAMAGE, SERIOUS INJURY OR DEATH.

Advisory:

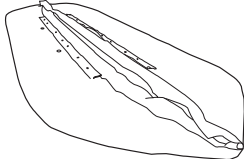
Pool owners may need to comply with local or state laws relating to childproof fencing, safety barriers, lighting, and other safety requirements. Customers should contact their local building code enforcement office for further details.

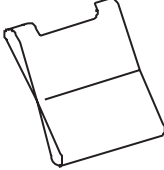
SAFETY RULES

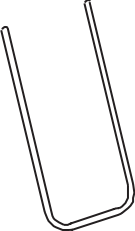
PARTS LIST

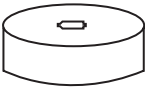
PARTS LIST		
1 	2 	3 
4 	5 	6 
7 	8 	9 
10 	11 	12 
13 	14 	

NOTE: Drawings for illustration purpose only. Actual product may vary. Not to scale.

PARTS REFERENCE

Before assembling your product, please take a few minutes to check the contents and become familiar with all the parts.

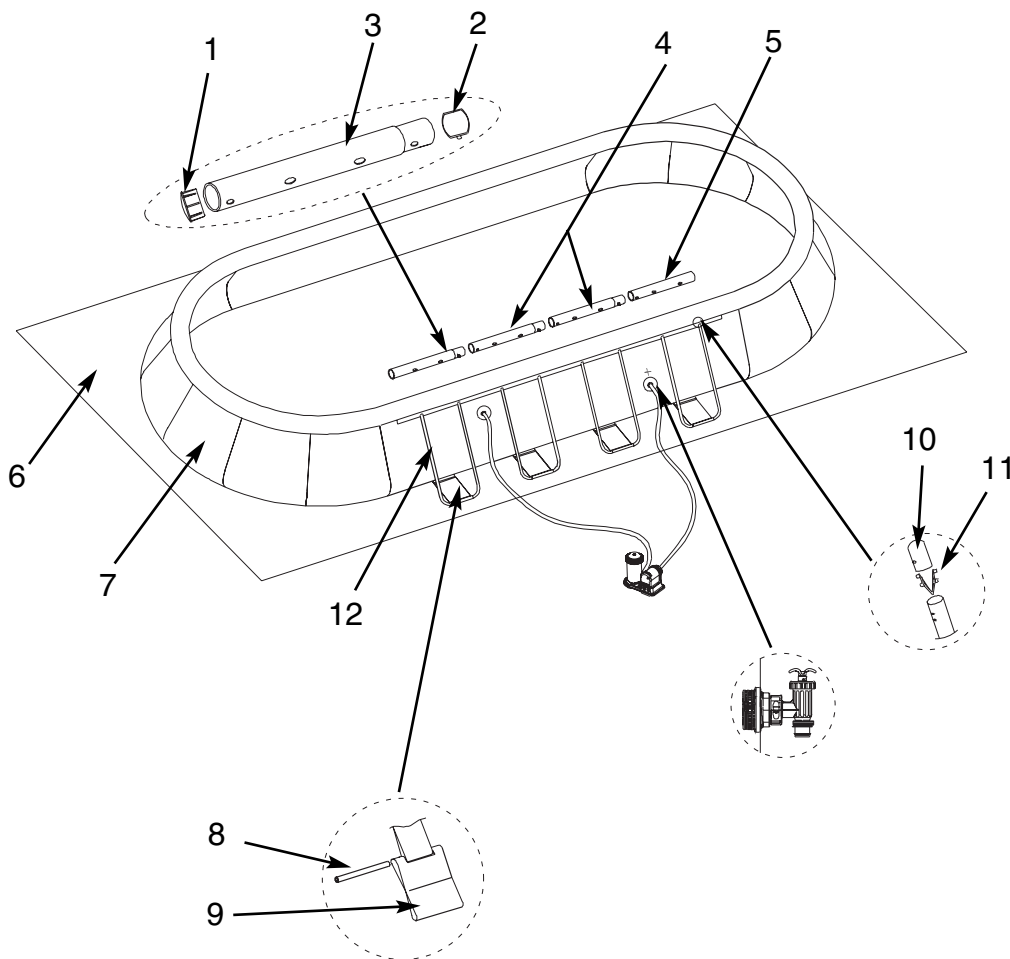

NOTE: Drawings for illustration purpose only. Actual product may vary. Not to scale.

PARTS REFERENCE

REF NO.	DESCRIPTION	POOL SIZE & QUANTITY			
		18' x 10' (549cm x 305cm)	20' x 12' (610cm x 366cm)	24' x 12' (732cm x 366cm)	28' x 12' (853cm x 366cm)
1	BEAM END CAP	4	4	4	4
2	SINGLE BUTTON SPRING	2	2	4	6
3	HORIZONTAL BEAM (A) (BEAM END CAP & SINGLE BUTTON SPRING INCLUDED)	2	2	2	2
4	HORIZONTAL BEAM (B) (SINGLE BUTTON SPRING INCLUDED)	0	0	2	4
5	HORIZONTAL BEAM (C) (BEAM END CAP INCLUDED)	2	2	2	2
6	GROUND CLOTH	1	1	1	1
7	POOL LINER (DRAIN VALVE CAP INCLUDED)	1	1	1	1
8	CONNECTING ROD	4	4	6	8
9	RESTRAINER STRAP	4	4	6	8
10	U-SUPPORT END CAP	8	8	12	16
11	DOUBLE BUTTON SPRING CLIP	8	8	12	16
12	U-SHAPE SIDE SUPPORT (U-SUPPORT END CAP & DOUBLE BUTTON SPRING CLIP INCLUDED)	4	4	6	8
13	DRAIN CONNECTOR	1	1	1	1
14	DRAIN VALVE CAP	1	2	2	2

PARTS REFERENCE

REF NO.	DESCRIPTION	16' x 10' x 42"	20' x 12' x 48"	24' x 12' x 48"	28' x 12' x 48"
		(549cm x 305cm x 107cm)	(610cm x 366cm x 122cm)	(732cm x 366cm x 122cm)	(853cm x 366cm x 122cm)
SPARE PART NO.					
1	BEAM END CAP	10380	10380	10380	10380
2	SINGLE BUTTON SPRING	10381	10381	10381	10381
3	HORIZONTAL BEAM (A) (BEAM END CAP & SINGLE BUTTON SPRING INCLUDED)	11099	11099	11099	11099
4	HORIZONTAL BEAM (B) (SINGLE BUTTON SPRING INCLUDED)			11100	11100
5	HORIZONTAL BEAM (C) (BEAM END CAP INCLUDED)	11101	11101	11101	11101
6	GROUND CLOTH	10872	10666	10667	10758
7	POOL LINER (DRAIN VALVE CAP INCLUDED)	10870	10768	10769	11014
8	CONNECTING ROD	10383	10383	10383	10383
9	RESTRAINER STRAP	10710	10710	10710	10710
10	U-SUPPORT END CAP	10379	10379	10379	10379
11	DOUBLE BUTTON SPRING CLIP	10382	10382	10382	10382
12	U-SHAPE SIDE SUPPORT (U-SUPPORT END CAP & DOUBLE BUTTON SPRING CLIP INCLUDED)	10877	10709	10709	10709
13	DRAIN CONNECTOR	10201	10201	10201	10201
14	DRAIN VALVE CAP	11044	11044	11044	11044

PARTS REFERENCE

POOL SETUP

IMPORTANT SITE SELECTION AND GROUND PREPARATION INFORMATION

⚠ WARNING

- The pool location must allow you to secure all doors, windows, and safety barriers to prevent unauthorized, unintentional or unsupervised pool entry.
- Install a safety barrier that will eliminate access to the pool for young children and pets.
- Failure to set up the pool on flat, level, compact ground and in accord with the following instructions could result in the pool's collapse or the possibility that a person lounging in the pool could be swept out, resulting in serious injury or property damage.
- Risk of electric shock: connect the filter pump only to a grounding type receptacle protected by a ground-fault circuit interrupter (GFCI) or residual current device (RCD). To reduce the risk of an electrical shock, do not use extension cords, timers, plug adapters or converter plugs to connect the pump to an electrical supply. Always provide a properly located outlet. Locate the cord where it cannot be damaged by lawn mowers, hedge trimmers, and other equipment. See the filter pump manual for additional warnings and instructions.

Select an outdoor location for the pool with the following in mind:

1. The area where the pool is to be set up must be **absolutely flat and level**. Do not set up the pool on a slope or inclined surface.
2. The ground surface must be compacted and firm enough to withstand the pressure and weight of a fully set up pool. **Do not** set up the pool on mud, sand, soft or loose soil conditions.
3. **Do not** set up the pool on a deck or platform.
4. The pool requires at least 5 - 6 feet (1.5 - 2.0m) of space all around pool from objects that a child could climb on to gain access to the pool.
5. The chlorinated poolwater could damage the surrounding vegetation. Certain types of grass such as St. Augustine and Bermuda, may grow through the liner.
6. If the ground is not concrete (i.e., if it is asphalt, lawn or earth) you must place a piece of pressure-treated wood, size 15" x 15" x 1.2" (38 x 38 x 3cm), under each U-shaped support and flush with the ground. Alternatively you may use steel pads or reinforced tiles.
7. Consult your local pool supply retailer for advice on support pads.

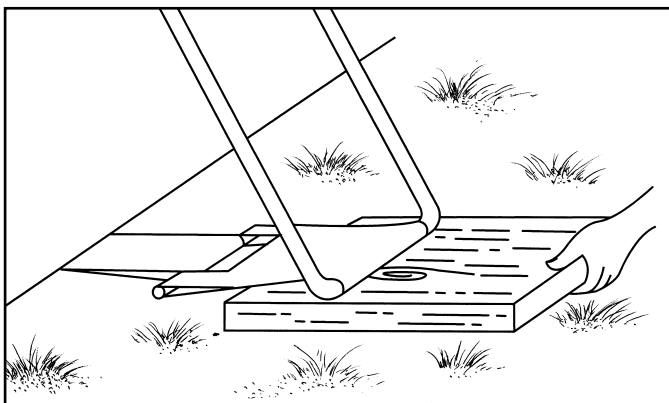

POOL SETUP (continued)

You may have purchased this pool with the Intex Krystal Clear™ filter pump. The pump has its own separate set of installation instructions. First assemble your pool unit and then set up the filter pump.

1. Remove the ground cloth from carton. Spread it out completely with its edges being at least 5 - 6' (1.5 - 2.0 m) from any obstacle such as walls, fences, trees, etc.

- Remove the liner (7) from carton and place it on top of the ground cloth with the drain valve towards the draining area. Place the drain valve away from the house. Open it up to warm it in the sun. This warming will make installation easier. Make sure the liner is centered atop the ground cloth. Be sure to face the end with the 2 hose connectors towards the electrical power source.

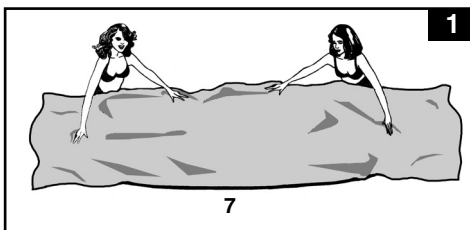

IMPORTANT: Do not drag the liner across the ground as this can cause leaks or other damages (see drawing 1).

2. Remove all the parts from the carton(s) and place them on the ground in the location where they are to be assembled (see drawings 2.1, 2.2 and 2.3). Check the parts listing and be sure all the pieces to be assembled are accounted for.

IMPORTANT: Do not start assembly if any pieces are missing. For replacement pieces call the Consumer Service telephone number in your area.

After all pieces are accounted for move the pieces away from the liner for of installation.

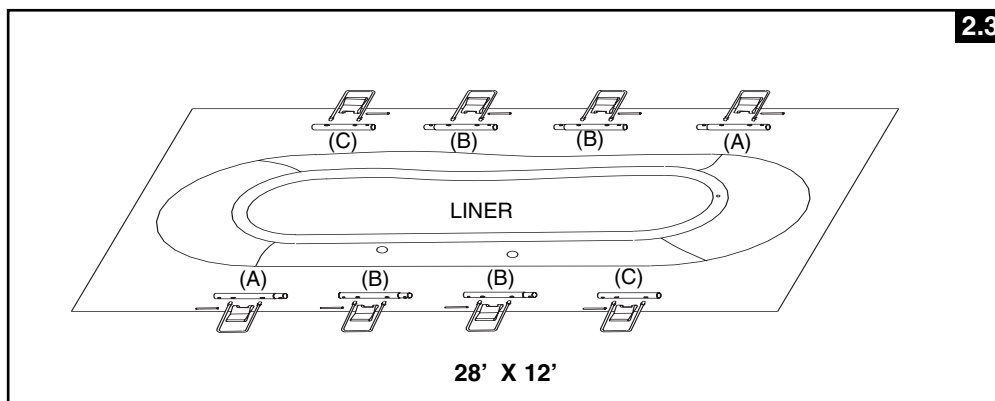
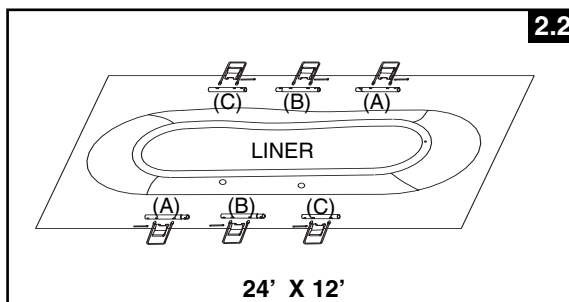
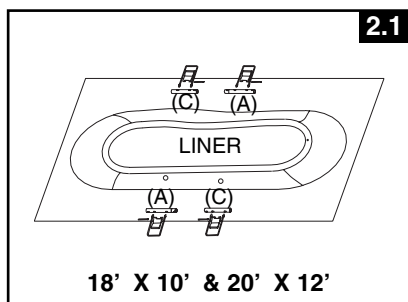

POOL SETUP (continued)

3. Be sure the liner is opened and spread out to its fullest extent on top of the ground cloth. Starting with one side, slide the closed end of "A" beam first into the sleeve openings located near the corner. Continue with "B" beam snapping into the "A" beam, and another "C" beam snapping into the "B" beam. Keep the metal beam holes aligned with the white liner sleeve holes. Continue inserting all "A-B-C" beams into the sleeve openings, and do the same on the other side. The combinations for beams are different for different sizes of pools, see the chart below for detail. (Be sure all sides end up with the metal beam holes aligned with the white liner sleeve holes.)

Size of Pool	No. of "U-shape" Leg on a side	Beam Combinations
18' x 10' (549 cm x 305 cm) & 20' x 12' (610 cm x 366 cm)	2	A-C
24' x 12' (732 cm x 366 cm)	3	A-B-C
28' x 12' (853 cm x 366 cm)	4	A-B-B-C

4. Slide the restrainer strap (9) onto the large U-shaped side support (12). Repeat for all restrainer straps and U-supports (see drawing 3). **IMPORTANT: The liner is to remain flat on the ground during the next step #5. This is why 5 - 6' of clearance space around the pool is necessary.**

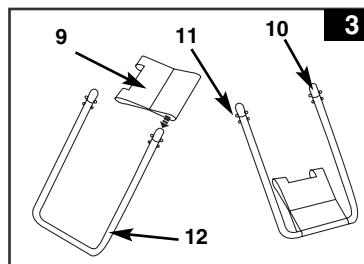

5. • The tops of the U-shaped side supports have a double button spring loaded clip that is factory pre-installed. Insert the side supports into the "A-B-C" beam holes by squeezing the bottom button inward with your fingers. • Squeezing this bottom button will allow the support to enter the beam. Once the U-support is inside the beam release the finger pressure allowing the support to "SNAP" into place. Repeat this procedure for all U-shaped side supports (see drawing 4).

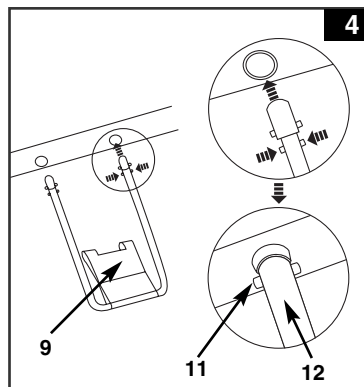

6. Insert the connecting rods into the overlapping openings, to connect the liner straps to the restrainer straps (see drawing 5).

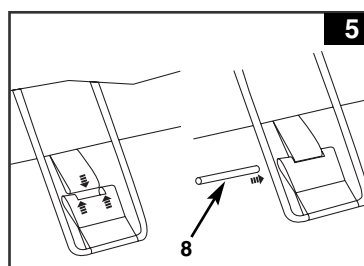

SETUP INSTRUCTIONS

POOL SETUP (continued)

7. Pull the bottoms of the side supports out away from the liner to make the straps taut. Repeat for all locations (see drawing 6).

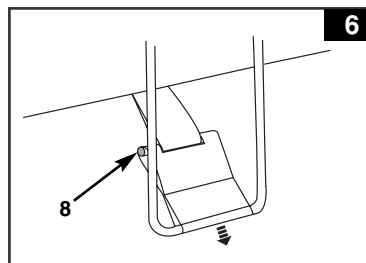

8. If the ground is not concrete (asphalt, lawn or earth) you must place a piece of pressure-treated wood, size 15" x 15" x 1.2", under each leg and flush with the ground. The U-shaped side supports must be placed in the center of the pressure-treated wood and with the wood grain perpendicular to the support leg (see drawing 7).

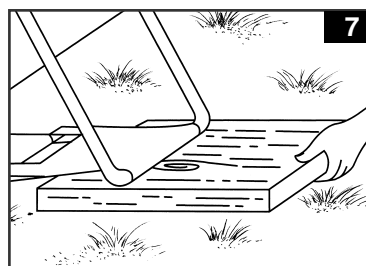

9. Flip the top ring out to ensure the top ring is fully outside of the wall line and facing up. Inflate the top ring, keeping it centered in the middle of the pool, with an air pump. **IMPORTANT: To prevent bursting, DO NOT use a high pressure pump such as an air compressor. DO NOT over inflate. Use an Intex manual inflation hand pump (not included).**

IMPORTANT

Proper inflation of the top ring.
The ambient temperatures of air and water have an effect on the top ring internal pressure.
The best procedure for maintaining proper inflation is to leave some room for daytime expansion as the sun heats the air inside the ring. During very hot weather check the ring to see if some air must be released to avoid damage.

In no event shall Intex, their authorized agents or employees be liable for damages (such as pin holes) to the inflatable top ring caused by negligence, ordinary wear and tear, abuse and carelessness, or external forces.

SETUP INSTRUCTIONS

POOL SETUP (continued)

10. Before filling with water, be sure:

- All the U-shaped side supports (12) are straight and properly aligned;
- All the restrainer straps (9) are positioned in the center of U-shaped side supports (12);
- The liner straps are pulled outwards from the pool bottom, and the restrainer straps (9) are taut or laying flat on the ground;
- The drain plug inside the pool is closed and the drain cap on the outside is screwed on tightly;

Fill the pool with no more than 1 inch of water; and look to see if there is any noticeable difference in the slope of the pool floor.

IMPORTANT: If the water in the pool flows to one side, the pool is not completely level. Setting up the pool on unlevel ground will cause the pool to tilt resulting in the sidewall material to bulge. If the pool is not completely level, you must drain the pool, level the area and re-fill the pool.

- Begin to smooth out the remainder of wrinkles (from inside pool) by pushing out where the pool floor and pool sides meet, or (from outside pool) reach under the pool side, grasp the pool floor and pull out. If the ground cloth is causing the wrinkles, have 2 persons pull from either side to remove all wrinkles.

11. Pool liner walls will rise while filling with water, water may be filled to the bottom of the inflated ring.

IMPORTANT: As the pool fills with water, check on the U-shaped side supports (12) to ensure they are straight and properly aligned with the horizontal top beams periodically until the pool is full of water.

IMPORTANT

Before allowing anyone to use the pool, hold a family meeting. Establish a set of rules that include, at a minimum, the important safety rules and general aquatic safety information in this manual. Review these rules on a regular basis and with all users of the pool, including guests.

POOL MAINTENANCE & CHEMICALS

WARNING

REMEMBER TO

- Protect all pool occupants from possible water-related illnesses by keeping the pool water clean. Do not swallow the pool water. Always practice good hygiene.
- Keep your pool clean and clear. The pool floor must be visible at all times from the outside barrier of the pool.
- Keep children away from pool covers to avoid entanglement, drowning, or other serious injury.

The maintenance of a proper water balance is the single most important factor in maximizing the life and appearance of the liner as well as ensuring clean, healthy and safe water. Proper technique is important for water testing. See your pool professional for chemical, test kits and testing procedures. Be sure to read and follow the written instructions from the chemical manufacturer.

1. Never let chlorine come in contact with the liner if it is not completely dissolved. Dissolve granular or tablet chlorine first in a bucket of water, then add it to the pool water. Likewise with liquid chlorine; mix it immediately and thoroughly with the pool water.
2. Never mix chemicals together. Add the chemicals to the pool water separately. Thoroughly dissolve each chemical before adding another one to the water.
3. An Intex pool skimmer and an Intex pool vacuum are available to assist in maintaining clean pool water. See your pool dealer for these pool accessories.
4. Do not use a pressure washer to clean the pool.

TROUBLESHOOTING

PROBLEM	DESCRIPTION	CAUSE	SOLUTION
ALGAE	<ul style="list-style-type: none"> • Greenish water. • Green or black spots on pool liner. • Pool liner is slippery and/or has a bad odor. 	<ul style="list-style-type: none"> • Chlorine and pH level need adjustment. 	<ul style="list-style-type: none"> • Super chlorinate with shock treatment. Correct pH to your pool store's recommended level. • Vacuum pool bottom. • Maintain proper chlorine level.
COLORED WATER	<ul style="list-style-type: none"> • Water turns blue, brown, or black when first treated with chlorine. 	<ul style="list-style-type: none"> • Copper, iron or manganese in water being oxidized by the added chlorine. Common. 	<ul style="list-style-type: none"> • Adjust pH to recommended level. • Run filter until water is clear. • Replace cartridge frequently.
FLOATING MATTER IN WATER	<ul style="list-style-type: none"> • Water is cloudy or milky. 	<ul style="list-style-type: none"> • "Hard water" caused by a too high pH level. • Chlorine content is low. • Foreign matter in water. 	<ul style="list-style-type: none"> • Correct the pH level. Check with your pool dealer for advice. • Check for proper chlorine level. • Clean or replace your filter.
CHRONIC LOW WATER LEVEL	<ul style="list-style-type: none"> • Level is lower than on previous day. 	<ul style="list-style-type: none"> • Rip or hole in pool liner or hoses. 	<ul style="list-style-type: none"> • Repair with patch kit. • Finger tighten all caps. • Replace the hoses.
SEDIMENT ON POOL BOTTOM	<ul style="list-style-type: none"> • Dirt or sand on pool floor. 	<ul style="list-style-type: none"> • Heavy use, getting in and out of pool. 	<ul style="list-style-type: none"> • Use Intex pool vacuum to clean bottom of pool.
SURFACE DEBRIS	<ul style="list-style-type: none"> • Leaves, insects etc. 	<ul style="list-style-type: none"> • Pool too close to trees. 	<ul style="list-style-type: none"> • Use Intex pool skimmer.

POOL MAINTENANCE & DRAINAGE



CAUTION

ALWAYS FOLLOW THE CHEMICAL MANUFACTURER'S DIRECTIONS, AND THE HEALTH AND HAZARD WARNINGS.

Do not add chemicals if the pool is occupied. This can cause skin or eye irritation. Concentrated chlorine solutions can damage the pool liner. In no event is Intex Recreation Corp., Intex Development Co. Ltd., their related companies, authorized agents and service centers, retailers or employees liable to the buyer or any other party for costs associated with the loss of pool water, chemicals or water damage. **Keep spare filter cartridges on hand. Replace cartridges every two weeks.** We recommend the use of a Krystal Clear™ Intex Filter Pump with all of our above-ground-pools.

EXCESSIVE RAIN: To avoid damage to the pool, immediately drain rain water that causes the water level to be higher than the maximum.

How to Drain Your Pool and Long Term Storage

Note: This pool has drain valves installed in 2 corners. Connect the garden hose to the corner valve that directs the water to the appropriate location.

1. Check local regulations for specific directions regarding disposal of swimming pool water.
2. Check to make sure that the drain plug inside the pool is plugged in place.
3. Remove the cap from the drain valve on the outside pool wall.
4. Attach the female end of the garden hose to the patented drain connector.
5. Place the other end of the hose in an area where the water can be safely drained away from the house.
6. Attach the drain connector to the drain valve. **NOTE: The drain connector will push the drain plug open inside the pool and water will start to drain immediately.**
7. Disconnect hose and adapter when finished.
8. Re-insert drain plug in drain valve on inside of pool for storage.
9. Replace drain cap on outside of pool.
10. Reverse the set up instructions to disassemble the pool. Completely deflate the top ring, and remove all plumbing parts.
11. Be sure that the pool and all parts are completely dry before folding. Let it lie in the sun for an hour (**see drawing 8**). Sprinkle some talcum powder to prevent the vinyl from sticking together and to absorb any moisture you may have missed.
12. Create rectangular shape. Starting at one side, fold one-sixth of liner in on itself twice. Do the same on the opposite side (**see drawings 9.1 & 9.2**).
13. Once you have created two opposing folded sides, simply fold one over the other like closing a book (**see drawings 10.1 & 10.2**).
14. Fold the two long ends to the middle (**see drawing 11**).
15. Fold one over the other like closing a book and finally compact the liner (**see drawing 12**).
16. Store the liner and accessories in a dry, temperature controlled, between 32 degrees Fahrenheit (0 degrees Celsius) and 104 degrees Fahrenheit (40 degrees Celsius), storage location.
17. The original packing can be used for storage.

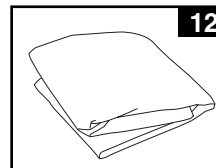
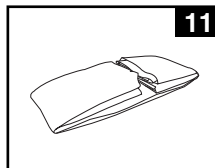
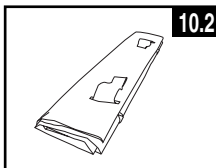
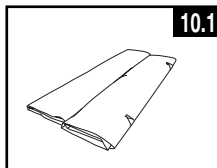
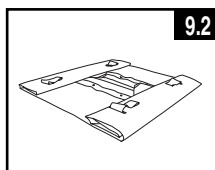
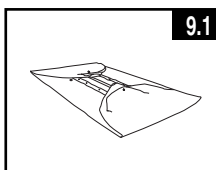
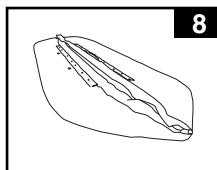

STORAGE & WINTERIZING

Winterizing your Above Ground Pool

After usage, you can easily empty and store away your pool in a safe place. Some people however, choose to leave their pool up all year round. In cold areas, where freezing temperatures occur, there can be a risk of ice damage to your pool unit. We therefore recommend you to drain, disassemble and properly store away the unit, when the temperature drops below 32 degrees Fahrenheit (0 degrees Celsius). Also see the section "How To Drain Your Pool".

Should you choose to leave your pool out, prepare it as follows:

1. Clean the pool water thoroughly. If the type is an Easy Set Pool or an Oval Frame Pool, make sure that the top ring is properly inflated.
2. Remove the skimmer (if applicable) or any accessories attached to the threaded strainer connector. Replace strainer grid if necessary. Be sure all accessories parts are clean and completely dry before storage.
3. Plug the Inlet and Outlet fitting from the inside of the pool with the plug provided (sizes 16' and below). Close the Inlet and Outlet Plunger Valve (sizes 17' and above).
4. Remove the ladder (if applicable) and store in a safe place. Be sure the ladder is completely dry before storage.
5. Remove the hoses that connect the pump and filter to the pool.
6. Add the appropriate chemicals for the winter period. Consult your local pool dealer as to which chemicals you should use and how to use them. This can vary greatly per region.
7. Cover pool with Intex Pool Cover. **IMPORTANT NOTE: INTEX POOL COVER IS NOT A SAFETY COVER.**
8. Clean and drain the pump, filter housing and hoses. Remove and discard the old filter cartridge. Keep a spare cartridge for the next season.
9. Bring pump and filter parts indoors and store in a safe and dry area, preferably between 32 degrees Fahrenheit (0 degrees Celsius) and 104 degrees Fahrenheit (40 degrees Celsius).

STORAGE

GENERAL AQUATIC SAFETY

Water recreation is both fun and therapeutic. However, it involves inherent risks of injury and death. To reduce your risk of injury, read and follow all product, package and package insert warnings and instructions. Remember, however, that product warnings, instructions and safety guidelines cover some common risks of water recreation, but do not cover all instances or risk and or danger.

For additional safeguards, also familiarize yourself with the following general guidelines as well as guidelines provided by nationally recognized Safety Organizations:

- Demand constant supervision.
- Learn to swim.
- Take the time to learn CPR and first aid.
- Instruct anyone who is watching your children about potential pool hazards and about the use of protective devices such as locked doors, barriers, etc.
- Teach children what to do in case of an emergency.
- Always use common sense and good judgement when enjoying any water activity.
- Supervise, supervise, supervise.

For service questions or to order replacement parts, please contact the appropriate office listed below or visit www.intexdevelopment.com for answers to most frequently asked questions.

AREAS	LOCATION	AREAS	LOCATION
• ASIA	INTEX DEVELOPMENT CO. LTD. 8TH FLOOR, DAH SING FINANCIAL CENTRE, 108 GLOUCESTER ROAD, WANCHAI, HONG KONG TEL: 852-28270000 FAX: 852-23118200 E-mail: xmservicesupport@intexcorp.com.cn Website: www.intexdevelopment.com	• ARGENTINA	JARSE INDUSTRIAL Y COMERCIAL S.A MANUEL GARCIA N°124, PARQUE PATRICO, BUENOS AIRES, ARGENTINA TEL: 4942-2238 (interno 106); TEL: 4942-2238 (interno 145) E-mail: Martin.Cosoletto@jarse.com.ar E-mail: Daniel.Centurion@jarse.com.ar
• EUROPE	INTEX TRADING B.V. POSTBUS 1075, 4700 BB ROOSENDAAL, THE NETHERLANDS TEL: 31-(0)165-593939 FAX: 31-(0)165-593969 E-mail: service@intexcorp.nl Website: www.intexcorp.nl	• PERU	AVENIDA COMANDANTE ESPINAR 142, MIRAFLORES, LIMA, PERU TEL: 446-9014
• FRANCE	UNITEX SERVICE (FRANCE) SAS 52, ROUTE NATIONALE, 39190 BEAUFORT, FRANCE TEL: 08 90 71 20 39 FAX: 03 84 25 18 09 E-mail: sav@intexcorp.com.fr Website: www.intex.fr	• SAUDI ARABIA	SAUDI ARABIAN MARKETING & AGENCIES CO. LTD. PRINCE AMIR MAJED STREET, AL-SAFA DISTRICT, JEDDAH, KINGDOM OF SAUDI ARABIA TEL: 966-2-693 8496 FAX: 966-2-271 4084 E-mail: toy@samaco.com.sa Website: www.samaco.com.sa
• GERMANY	C/O WEBOPAC LOGISTICS GMBH INTER-LOGISTIK-PARK 1-3 87600 KAUFBEUREN TEL: 0180 5 405 100 200 (0,14€/min aus dem Festnetz, Mobilfunk max. 0,42€/min) FAX: + 43 (7262) 61439 E-mail: service@intexcorp.de Website: www.intexcorp.de	• AUSTRIA	STEINBACH VERTRIEBSGMBH AISTINGERSTRASSE 2 4311 SCHWERTBERG TEL: 0820 - 200 100 200 (0,145€/min aus allen Netzen) FAX: + 43 (7262) 61439 E-mail: service@intexcorp.at Website: www.intexcorp.at
• ITALY	A & A MARKETING SERVICE VIA RAFFAELLO SANZIO 20058 VILLASANTA (MI) TEL: 199 12 19 78 FAX: +39 039 2058204 E-mail: intex@acamarketingsservice.com Website: www.intexitalia.com	• CZECH REPUBLIC / EASTERN EUROPE	INTEX TRADING S.R.O. BENESOVSKA 23, 101 00 PRAHA 10, CZECH REPUBLIC TEL: +420-267 313 188 FAX: +420-267 312 552 E-mail: info@intexcorp.cz
• UK	TOY BROKERS LTD MARKETING HOUSE, BLACKSTONE ROAD, HUNTINGDON, CAMBS. PE29 6EF, UK TEL: 0844 561 7129 FAX: 01480 414761 E-mail: sales@toybrokers.com Website: www.intexspares.com	• BELGIUM	N.V. SIMBA-DICKIE BELGIUM S.A. MOESKROENSENSTEENWEG 383C, 8511 AALBEKE, BELGIUM TEL: 0800 92088 FAX: 32-56.26.05.38 E-mail: intex@nicotoy.be E-mail: intexsupport@nicotoy.be
• SWITZERLAND	GWM AGENCY GARTEN-U. WOHNMÖBEL, RÄFFELSTRASSE 25, POSTFACH, CH-8045 ZÜRICH/SWITZERLAND TEL: 0900 455456 or +41 44 455 50 60 FAX: +41 44 455 50 65 E-mail: gwm@gwm.ch Website: www.gwm.ch	• DENMARK	K.E. MATHIASSEN A/S SINTRUPVEJ 12, DK-8220 BRABRAND, DENMARK TEL: +45 89 44 22 00 FAX: +45 86 24 02 39 E-mail: intex@keleg.dk Website: www.intexnordic.com
• SPAIN / PORTUGAL	Nostrum Iberian Market S.A. Av. de la Albufera, 321 28031 Madrid, Spain TEL: +34 902101339 FAX: +34 902908976 Email for Spain: sat@intexiberian.com Email for Portugal: spv-pt@intexiberian.com Website: www.intexiberian.com	• SWEDEN	LEKSAM AB BRANDSVIGSGATAN 6, S-262 73 ÄNGELHOLM, SWEDEN TEL: +46 431 44 41 00 FAX: +46 431 190 35 E-mail: intex@leksam.se Website: www.intexnordic.com
• AUSTRALIA	HUNTER OVERSEAS PTY LTD LEVEL 1, 225 BAY STREET, BRIGHTON, VICTORIA, AUSTRALIA TEL: 61-3-9596-2144 or 1800-224-094 FAX: 61-3-9596-2188 E-mail: enquiries@hunteroverseas.com.au Website: www.hunteroverseas.com.au	• NORWAY	NORSTAR AS PINDSLEVEIEN 1, N-3221 SANDEFJORD, NORWAY TEL: +47 33 48 74 10 FAX: +47 33 48 74 11 E-mail: intex@norstar.no Website: www.intexnordic.com
• NEW ZEALAND	HAKA NEW ZEALAND LIMITED UNIT 4, 11 ORBIT DIVE, ALBANY, AUCKLAND 0757, NEW ZEALAND TEL: 649-4159213 FAX: 649-4159212 E-mail: geoff@hakanz.co.nz	• FINLAND	SUOMALAISTENTIE 7, FIN-02270 ESPOO, FINLAND TEL: +358 9 8190 530 FAX: +358 9 8190 5335 E-mail: info@norstarfi.com Website: www.intexnordic.com
• MIDDLE EAST REGION	FIRST GROUP INTERNATIONAL AL MOOSA GROUP BUILDING, 1ST FLOOR, OFFICE 102 & 103, UMM HURAIR ROAD, KARAMA, DUBAI, UAE TEL: 00971-4-3373322 FAX: 00971-4-3375115 E-mail: info@firstgroupinternational.com Website: www.firstgroupinternational.com	• RUSSIA	LLC BAUER KIEVSKAYA STR. 20, 121165 MOSCOW, RUSSIA TEL: 099-249-9400/8626/9802 FAX: 095-742-8192 E-mail: intex.russia@gmail.com Website: www.intex.su
• SOUTH AFRICA	WOOD & HYDE 15-17 PACKER AVENUE, INDUSTRIA 2, CAPE TOWN, SOUTH AFRICA 7460 TEL: 27-21-0800-204-692 FAX: 27-21-505-5600 E-mail: ygoldman@melbro.co.za	• POLAND	KATHAY HASTER UL. LUTYCKA 3, 60-415 POZNAN TEL: +48 61 8498 381/380 FAX: +48 61 8474 487 E-mail: inx@kathay.com.pl Website: www.intexpoland.pl
• CHILE / URUGUAY	COMEXA S.A. EL JUNCAL 100, PARQUE INDUSTRIAL PORTEZUELO, QUILICURA, SANTIAGO, CHILE. TEL: 600-822-0700 E-mail: serviciotecnico@silfa.cl	• HUNGARY	RECONTRA LTD./RICKI LTD. H-1113 BUDAPEST, DARÓCZI ÚT 1-3, HUNGARY TEL: +361 372 5200/113 FAX: +361 209 2634 E-mail: service@recontra.hu
		• BRASIL	KONESUL MARKETING & SALES LTDA RUA ANTONIO DAS CHAGAS, 1.528 - CEP. 04714-002, CHACARA SANTO ANTONIO - SÃO PAULO - SP - BRASIL TEL: 55 (11) 5181 4646 FAX: 55 (11) 5181 4646 E-mail: sacintexbrasil@uol.com.br
		• ISRAEL	ALFIT TOYS LTD MOSHAV NEHALIM, MESHEK 32, 49950, ISRAEL TEL: +972-3-9076666 FAX: +972-3-9076660 E-mail: michald@chagim.co.il